









Cisco Unified IP Phone 7960G and 7940G Phone Guide for Cisco Unified Communications Manager 7.0 (SCCP)

Americas Headquarters

Cisco Systems, Inc.
170 West Tasman Drive
San Jose, CA 95134-1706
USA
<http://www.cisco.com>
Tel: 408 526-4000
800 553-NETS (6387)
Fax: 408 527-0883

Common Phone Tasks

View online help on the phone	Press  or  twice quickly.
Place a call	Go off-hook before or after dialing a number.
Redial a number	Press Redial .
Switch to the speaker or headset during a call	Press  or  , then hang up the handset.
Mute your phone	Press  .
Use your call logs	Choose  to choose a call log. To dial, highlight a listing and go off-hook.
Edit a number	Press EditDial , << or >>.
Hold/resume a call	Press Hold or Resume .
Transfer a call to a new number	Press Transfer , enter a target number, then press Transfer again.
Start a standard conference call	Press more > Confrn . Dial a number, then press Confrn again. Repeat for each party



Cisco, Cisco Systems, the Cisco logo, and the Cisco Systems logo are registered trademarks or trademarks of Cisco Systems, Inc. and/or its affiliates in the United States and certain other countries. All other trademarks mentioned in this document or Website are the property of their respective owners. The use of the word partner does not imply a partnership relationship between Cisco and any other company. (0705R)

© 2008 Cisco Systems, Inc. All rights reserved.

OL-14584-01



QUICK REFERENCE



Cisco Unified IP Phone 7960G and 7940G for Cisco Unified Communications Manager 7.0 (SCCP)

















Softkey Definitions
Phone Screen Icons
Phone Screen Icons
Common Phone Tasks

Softkey Definitions







AbbrDial	Dial using a speed dial index number
Answer	Answer a call
Barge	Add yourself to a call on a shared line
CallBack	Receive notification when a busy extension becomes available
Cancel	Cancel an action or exit a screen without applying changes
cBarge	Add yourself to a call on a shared line and establish a conference
CFwdALL	Setup/cancel call forwarding
Clear	Delete records or settings
Conflist	View conference participants
Confrn	Create a conference call
Delete	Remove characters at the cursor when using EditDial
Dial	Dial a phone number
DirTrfr	Transfer two calls to each other
EditDial	Edit a number in a call log
EndCall	Disconnect the current call
Exit	Return to the previous screen
GPickUp	Answer a call ringing in another group
iDivert	Send a call to your voice messaging system
Join	Join several calls already on a single line to create a conference
MeetMe	Host a Meet-Me conference call
more	Display additional softkeys
NewCall	Make a new call

OPickUp	Answer a call ringing in another group that is associated with your group
Park	Store a call using Call Park
PickUp	Answer a call in your group
QRT	Submit call problems to the system administrator
Redial	Redial the most recently dialed number
Remove	Remove a conference participant
Resume	Resume a call on hold
RmLstC	Drop the last party added to a conference call
Save	Save the chosen settings
Search	Search for a directory listing
Select	Select an item on the screen
Transfer	Transfer a call
Update	Refresh content
VidMode	Choose a video display mode
<<	Delete characters to left of cursor
>>	Move through entered characters

Phone Screen Icons

Call State	
	Call Forwarding enabled
	Call on hold
	Connected call
	Incoming call
	Off-hook line
	Outgoing call
	Shared line in use
Secure Calls	
	Authenticated call
	Encrypted call
Critical Calls	
	Priority call
	Medium priority call
	High priority call
	Highest priority call
Selected Device	
	Handset in use
	Headset in use
	Speakerphone in use

Other Features

	Busy speed-dial line
	Idle in speed-dial line
	Speed Dial (line status unknown)
	Message waiting
	Video enabled
	Option selected
	Feature enabled

Button Icons

	Messages
	Services
	Help
	Directories
	Settings
	Speaker
	Mute
	Headset

Contents

Getting Started 1

Using this Guide 1

Finding Additional Information 2

 Accessing Cisco Unified IP Phone 7960G or 7940G eLearning Tutorials 2

Safety and Performance Information 2

Cisco Product Security Overview 3

Accessibility Features 3

Connecting Your Phone 4

An Overview of Your Phone 7

Understanding Buttons and Hardware 7

Understanding Phone Screen Features 10

 Cleaning the Phone Screen 10

Understanding Feature Buttons and Menus 11

 Understanding the Help System on Your Phone 11

Understanding Lines vs. Calls 12

 Understanding Line and Call Icons 12

Understanding Feature Availability 12

Basic Call Handling 13

Placing a Call—Basic Options 13

Placing a Call—Additional Options 14

Answering a Call 15

Ending a Call 16

Using Hold and Resume 16

Using Mute 16

Switching Between Multiple Calls 17

Viewing Multiple Calls	17
Transferring Calls	18
Forwarding Calls to Another Number	19
Making Conference Calls	20
Understanding Types of Conference Calls	20
Starting and Joining a Standard Conference	21
Starting or Joining a Meet-Me Conference Call	23

Advanced Call Handling 24

Speed Dialing	24
Picking Up Redirected Calls on Your Phone	25
Using a Shared Line	26
Understanding Shared Lines	26
Adding Yourself to a Shared-Line Call	27
Preventing Others from Viewing or Barging a Shared-Line Call	28
Storing and Retrieving Parked Calls	28
Making and Receiving Secure Calls	29
Tracing Suspicious Calls	29
Prioritizing Critical Calls	30
Using Cisco Extension Mobility	31
Using BLF to Determine a Line State	31

Using a Handset, Headset, and Speakerphone 32

Using a Handset	32
Using a Headset	32
Using a Speakerphone	33
Using AutoAnswer with a Headset or Speakerphone	33

Using Phone Settings 34

Customizing Rings and Message Indicators	34
Customizing the Phone Screen	35

Using Call Logs and Directories 36



Using Call Logs	36
-----------------	----

Directory Dialing	37
Using Corporate Directory on Your Phone	37
Using Personal Directory on Your Phone	38
Accessing Voice Messages	40
Customizing Your Phone on the Web	41
Accessing Your User Options Web Pages	41
Configuring Features and Services on the Web	42
Using Personal Directory on the Web	42
Using Your Personal Address Book on the Web	42
Configuring Fast Dials on the Web	43
Using the Address Book Synchronization Tool	44
Setting Up Speed Dials on the Web	44
Setting Up Phone Services on the Web	45
Controlling User Settings on the Web	46
Controlling Line Settings on the Web	47
Using Cisco WebDialer	49
Understanding Additional Configuration Options	51
Troubleshooting Your Phone	53
General Troubleshooting	53
Viewing Phone Administration Data	54
Using the Quality Reporting Tool	54
Cisco One-Year Limited Hardware Warranty Terms	55
Index	57

Getting Started

Using this Guide

This guide provides you with an overview of the features available on your phone. You can read it completely for a solid understanding of your phone's capabilities, or refer to the table below for pointers to commonly used sections.

If you want to...	Then...
Explore your phone on your own	Press  or  on the phone when you need assistance.
Review safety information	See the “Safety and Performance Information” section on page 2 .
Connect your phone	See the “Connecting Your Phone” section on page 4 .
Use your phone after it is installed	Start with the “An Overview of Your Phone” section on page 7 .
Learn about the phone buttons	See the “Understanding Buttons and Hardware” section on page 7 .
Learn about the phone screen	See the “Understanding Phone Screen Features” section on page 10 .
Make calls	See the “Placing a Call—Basic Options” section on page 13 .
Put calls on hold	See the “Using Hold and Resume” section on page 16 .
Mute calls	See the “Using Mute” section on page 16 .
Transfer calls	See the “Transferring Calls” section on page 18 .
Make conference calls	See the “Making Conference Calls” section on page 20 .
Set up speed dialing	See the “Speed Dialing” section on page 24 .
Share a phone number	See the “Using a Shared Line” section on page 26 .
Use your phone as a speakerphone	See the “Using a Handset, Headset, and Speakerphone” section on page 32 .
Change the ring volume or tone	See the “Using Phone Settings” section on page 34 .
View your missed calls	See the “Using Call Logs” section on page 36 .
Listen to your voice messages	See the “Accessing Voice Messages” section on page 40 .
See softkey and icon definitions	Refer to the Quick Reference Card in the front of this guide.

Finding Additional Information

You can access the most current Cisco Unified IP Phone documentation on the World Wide Web at this URL:

http://www.cisco.com/en/US/products/hw/phones/ps379/tsd_products_support_series_home.html

You can access the Cisco website at this URL:

<http://www.cisco.com/>

You can access International Cisco websites from this URL:

http://www.cisco.com/public/countries_languages.shtml

You can access the most current Licensing Information at this URL:

http://www.cisco.com/en/US/docs/voice_ip_comm/cuipph/all_models/openssl_license/7900_ssllic.html

Accessing Cisco Unified IP Phone 7960G or 7940G eLearning Tutorials

(SCCP phones only.)

Cisco Unified IP Phone 7960G or 7940G eLearning tutorials use audio and animation to demonstrate basic calling features. You can access eLearning tutorials online (for several phone models) from your personal computer. Look for the eLearning tutorial (English only) for your phone model in the documentation list at the following location:

http://www.cisco.com/en/US/products/hw/phones/ps379/products_user_guide_list.html



Note Although eLearning tutorials for the 7960G/7940G Cisco Unified IP Phones do not exist, refer to the Cisco Unified IP Phone 7900 Series eLearning tutorials for an overview of the common IP phone features and functionality.

Safety and Performance Information

Refer to these sections for information about the impact of power outages and other devices on your Cisco Unified IP Phone.

Power Outage

Your accessibility to emergency service through the phone is dependent on the phone being powered. If there is an interruption in the power supply, Service and Emergency Calling Service dialing will not function until power is restored. In the case of a power failure or disruption, you may need to reset or reconfigure equipment before using the Service or Emergency Calling Service dialing.

Using External Devices

The following information applies when you use external devices with the Cisco Unified IP Phone:

Cisco recommends the use of good quality external devices (such as headsets) that are shielded against unwanted radio frequency (RF) and audio frequency (AF) signals.

Depending on the quality of these devices and their proximity to other devices such as mobile phones or two-way radios, some audio noise may still occur. In these cases, Cisco recommends that you take one or more of the following actions:

- Move the external device away from the source of the RF or AF signals.
- Route the external device cables away from the source of the RF or AF signals.
- Use shielded cables for the external device, or use cables with a better shield and connector.
- Shorten the length of the external device cable.
- Apply ferrites or other such devices on the cables for the external device.

Cisco cannot guarantee the performance of the system because Cisco has no control over the quality of external devices, cables, and connectors. The system will perform adequately when suitable devices are attached using good quality cables and connectors.

**Caution**

In European Union countries, use only external speakers, microphones, and headsets that are fully compliant with the EMC Directive [89/336/EC].

Cisco Product Security Overview

This product contains cryptographic features and is subject to United States and local country laws governing import, export, transfer and use. Delivery of Cisco cryptographic products does not imply third-party authority to import, export, distribute or use encryption. Importers, exporters, distributors and users are responsible for compliance with U.S. and local country laws. By using this product you agree to comply with applicable laws and regulations. If you are unable to comply with U.S. and local laws, return this product immediately.

A summary of U.S. laws governing Cisco cryptographic products may be found at: <http://www.cisco.com/wwl/export/crypto/tool/stqrg.html>. If you require further assistance please contact us by sending email to export@cisco.com.

Accessibility Features

A list of accessibility features is available upon request. You can find more information about Cisco accessibility features at this URL:

www.cisco.com/go/accessibility

Connecting Your Phone

Your system administrator will likely connect your new Cisco Unified IP Phone to the corporate IP telephony network. If that is not the case, refer to the graphic and table below to connect your phone.

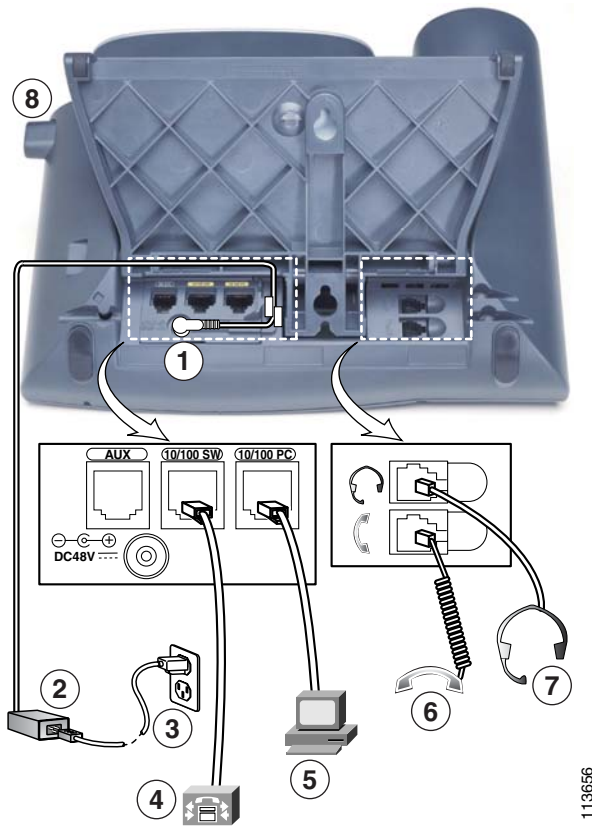

113656

1	DC adaptor port (DC48V)	5	Access port (10/100 PC)
2	AC-to-DC power supply	6	Handset port
3	AC power cord	7	Headset port
4	Network port (10/100 SW)	8	Footstand button

Adjusting the Footstand

To change the angle of the phone base, adjust the footstand while pressing the footstand button.

Adjusting the Handset Rest

Cisco recommends adjusting the handset rest, particularly when wall-mounting the phone, as this will ensure that the receiver will not readily slip out of the cradle. See the table below for instructions.

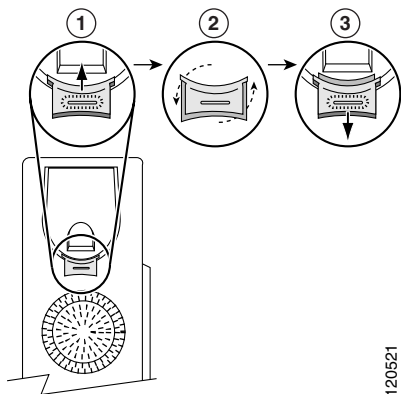

1	Set the handset aside and pull the square plastic tab from the handset rest.
2	Rotate the tab 180 degrees.
3	Slide the tab back into the handset rest. An extension protrudes from the top of the rotated tab. Return the handset to the handset rest.

Registering with TAPS

After your phone is connected to the network, your system administrator might ask you to auto-register your phone using TAPS (Tool for Auto-Registered Phones Support). TAPS might be used for a new phone or to replace an existing phone.

To register with TAPS, pick up the handset, enter the TAPS extension provided by your system administrator, and follow the voice prompts. You might need to enter your entire extension, including the area code. After your phone displays a confirmation message, hang up. The phone will re-start.

Headset Support

Although Cisco Systems performs limited internal testing of third-party headsets for use with the Cisco Unified IP Phones, Cisco does not certify or support products from headset (or handset) vendors.

Cisco recommends the use of good quality external devices, for example, headsets that are screened against unwanted radio frequency (RF) and audio frequency (AF) signals. Depending on the quality of these devices and their proximity to other devices such as mobile phones and two-way radios, some audio noise or echo may still occur. An audible hum or buzz may be heard by either the remote party or by both the remote party and the Cisco Unified IP Phone user. Humming or buzzing sounds can be caused by a range of outside sources: for example, electric lights, electric motors, or large PC monitors. See the [“Using External Devices”](#) section on [page 2](#) for more information.

**Note**

In some cases, hum may be reduced or eliminated by using a local power cube or power injector.

These environmental and hardware inconsistencies in the locations where Cisco Unified IP Phones are deployed means that there is not a single headset solution that is optimal for all environments.

Cisco recommends that customers test headsets in their intended environment to determine performance before making a purchasing decision and deploying en masse.

Audio Quality Subjective to the User

Beyond the physical, mechanical and technical performance, the audio portion of a headset must sound good to you (the user) and to the party on the far end. Sound quality is subjective and Cisco cannot guarantee the performance of any headsets. However, a variety of headsets from leading headset manufacturers have been reported to perform well with Cisco Unified IP Phones. See manufacturer's sites for details.

An Overview of Your Phone

Your Cisco Unified IP Phone 7960G or 7940G is a full-feature telephone that provides voice communication over the same data network that your computer uses, allowing you to place and receive phone calls, put calls on hold, speed dial numbers, transfer calls, make conference calls, and so on.

In addition to basic call-handling features, your phone can provide enhanced productivity features that extend your call-handling capabilities. Depending on configuration, your phone supports:

- Access to network data, XML applications, and web-based services.
- Online customizing of phone features and services from your User Options web pages.
- An online help system that displays information on your phone screen.

Understanding Buttons and Hardware

You can use the graphics and the table below to identify buttons and hardware on your phone.

Cisco Unified IP Phone 7960G











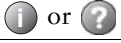

Cisco Unified IP Phone 7940G



68562



Item	Description	For more information, see...	
1	Handset light strip	Indicates an incoming call or new voice message.	Accessing Voice Messages, page 40
2	Phone screen	Shows phone features.	Understanding Phone Screen Features, page 10
3	Model type	Indicates your Cisco Unified IP Phone model.	Understanding Lines vs. Calls, page 12
4	Programmable buttons	Depending on configuration, programmable buttons provide access to: <ul style="list-style-type: none"> Phone lines (line buttons) Speed-dial numbers (speed-dial buttons, including the BLF speed-dial feature) Web-based services (for example, a Personal Address Book button) Phone features (for example, a Privacy button) 	Understanding Phone Screen Features, page 10
5	Footstand button	Allows you to adjust the angle of the phone base.	Adjusting the Footstand, page 4

6	Directories button 	Opens/closes the Directories menu. Use it to access call logs and directories.	Using Call Logs, page 36
7	Help button 	Activates the Help menu.	Understanding the Help System on Your Phone, page 11
8	Settings button 	Opens/closes the Settings menu. Use it to change phone screen and ring settings.	Using Phone Settings, page 34
9	Speaker button 	Toggles the speakerphone on or off. When the speakerphone is on, the button is lit.	Using a Handset, Headset, and Speakerphone, page 32
10	Mute button 	Toggles the Mute feature on or off. When Mute is on, the button is lit.	Using Mute, page 16
11	Headset button 	Toggles the headset on or off.	Using a Handset, Headset, and Speakerphone, page 32
12	Volume button 	Controls the volume and other settings.	Using Phone Settings, page 34
13	Services button 	Opens/closes the Services menu.	Customizing Your Phone on the Web, page 41
14	Messages button 	Auto-dials your voice message service (varies by service).	Accessing Voice Messages, page 40
15	Navigation button 	Allows you to scroll through menus.	Using Call Logs, page 36
16	Keypad	Allows you to dial phone numbers, enter letters, and choose menu items.	Basic Call Handling, page 13
17	Softkey buttons 	Each activates a softkey option (displayed on your phone screen).	Understanding Phone Screen Features, page 10

Understanding Phone Screen Features

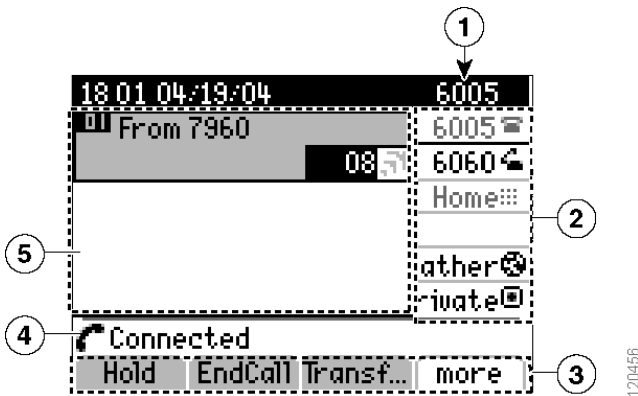
This is what your main phone screen might look like with an active call and several feature menus open.









1	Primary phone line	Displays the phone number (extension number) for your primary phone line.
2	Programmable button indicators	Programmable buttons  can serve as phone line buttons, speed dial buttons, phone service buttons or phone feature buttons. Icons and labels indicate how these buttons are configured. For an icon reference, see the “Phone Screen Icons” section in the quick reference card at the front of this guide.
3	Softkey labels	Each displays a softkey function. To activate a softkey, press the softkey button  .
4	Status line	Displays audio mode icons, status information, and prompts.
5	Call activity area	Displays calls per line, including caller ID, call duration and call state for the highlighted line (standard view). See the “Understanding Lines vs. Calls” section on page 12 and the “Viewing Multiple Calls” section on page 17.

Cleaning the Phone Screen

Gently wipe the phone screen with a soft, dry cloth. Do not use any liquids or powders on the phone. Using anything other than a soft, dry cloth can contaminate phone components and cause failures.











Understanding Feature Buttons and Menus

Press a feature button to open or close a feature menu.

If you want to...	Then...
Open or close a feature menu	Press a feature button: <ul style="list-style-type: none">  Messages  Services  or  Help  Directories  Settings
Scroll through a list or menu	Press the Navigation button.
Go back one level in a feature menu	Press Exit . Pressing Exit from the top level of a menu closes the menu.

Understanding the Help System on Your Phone

Your phone provides an online help system. Help topics appear on the phone screen.

If you want to...	Then...
View the main menu	Press  or  on your phone and wait a few seconds for the menu to display.
Learn about a button or softkey	Press  or  , then quickly press a button or softkey.
Learn about a menu item	Press  or  then quickly select the menu item on the phone screen. Or, press  or  twice quickly with the menu item highlighted.
Get help using Help	Press  or  twice quickly (without first selecting a menu item).











Understanding Lines vs. Calls

To avoid confusion about lines and calls, refer to these descriptions:

- Lines—Each corresponds to a directory number that others can use to call you. The Cisco Unified IP Phone 7960G supports up to six lines and the Cisco Unified IP Phone 7940G supports up to two lines. To see how many lines you have, look at the line area of your phone screen. You have as many lines as you have directory numbers and phone line icons. 
- Calls —Each line can support multiple calls. By default, your phone supports four connected calls per line, but your system administrator can adjust this number according to your needs. Only one call can be active at any time; other calls are automatically placed on hold.

Understanding Line and Call Icons

Your phone displays icons to help you determine the line and call state.

Icon	Call State	Description
	On-hook line	No call activity on this line.
	Off-hook line	You are dialing a number or an outgoing call is ringing.
	Connected call	You are connected to the other party.
	Ringing call	A call is ringing on one of your lines.
	Call on hold	You have put this call on hold. See the “Using Hold and Resume” section on page 16.
	Remote-in-use	Another phone that shares your line has a connected call. See the “Using a Shared Line” section on page 26.
	Authenticated call	See the “Making and Receiving Secure Calls” section on page 29.
	Encrypted call	See the “Making and Receiving Secure Calls” section on page 29.
	Idle line (BLF)	See the “Using BLF to Determine a Line State” section on page 31.
	Busy line (BLF)	See the “Using BLF to Determine a Line State” section on page 31.

Understanding Feature Availability





Depending on your phone system configuration, features included in this Phone Guide might not be available to you or might work differently on your phone. Contact your support desk or system administrator for information about feature operation or availability.

Basic Call Handling

You can perform basic call-handling tasks using a range of features and services. Feature availability can vary; see your system administrator for more information.

Placing a Call—Basic Options

Here are some easy ways to place a call on your Cisco Unified IP Phone.





If you want to...	Then...	For more information, see...
Place a call using the handset	Pick up the handset and enter a number.	An Overview of Your Phone, page 7
Place a call using the speakerphone	Press  and enter a number.	Using a Handset, Headset, and Speakerphone, page 32
Place a call using a headset	Press  and enter a number. Or, if  is lit, press New Call and enter a number.	Using a Handset, Headset, and Speakerphone, page 32
Redial a number	Press Redial to dial the last number.	Using Call Logs, page 36
Place a call while another call is active (using the same line)	<ol style="list-style-type: none"> 1. Press Hold. 2. Press New Call. 3. Enter a number. 	Using Hold and Resume, page 16
Dial from a call log	<ol style="list-style-type: none"> 1. Choose  > Missed Calls, Received Calls, or Placed Calls. 2. Select the listing or scroll to it and go off-hook. 	Using Call Logs, page 36

Tip

If you make a mistake while dialing, press << to erase digits.

Placing a Call—Additional Options







You can place calls using special features and services that might be available on your phone. See your system administrator for more information about these additional options.

If you want to...	Then...	For more information, see...
Place a call while another call is active (using a different line)	<ol style="list-style-type: none"> 1. Press  for a new line. The first call is automatically placed on hold. 2. Enter a number. 	Using Hold and Resume, page 16
Speed dial a number	<p>Do one of the following:</p> <ul style="list-style-type: none"> • Press  (a speed-dial button). • Use the Abbreviated Dial feature. • Use the Fast Dial feature. 	Speed Dialing, page 24
Dial from a corporate directory on your phone	<ol style="list-style-type: none"> 1. Choose  > Corporate Directory (name can vary). 2. Enter a name and press Search. 3. Select the listing or scroll to it and go off-hook. 	Using Call Logs, page 36
Use Call Back to receive notification when a busy or ringing extension is available	<ol style="list-style-type: none"> 1. Press CallBack while listening to the busy tone or ring sound. 2. Hang up. Your phone alerts you when the line is free. 3. Place the call again. 	Your system administrator
See if a line associated with a speed-dial is busy before placing a call to that line	Look for Busy Lamp Field indicators.	Using BLF to Determine a Line State, page 31
Make a priority (precedence) call	Enter the MLPP access number, then enter a phone number.	Prioritizing Critical Calls, page 30
Dial from a Personal Address Book (PAB) entry	<ol style="list-style-type: none"> 1. Choose  > Personal Directory to log in. 2. Choose Personal Address Book and search for a listing. 	Using Personal Directory on Your Phone, page 38

If you want to...	Then...	For more information, see...
Place a call using a billing or tracking code	<ol style="list-style-type: none"> 1. Dial a number. 2. After the tone, enter a client matter code (CMC) or a forced authorization code (FAC). 	Your system administrator
Place a call using your Extension Mobility profile	Log in to the Extension Mobility service on a phone	Using Cisco Extension Mobility, page 31



Answering a Call

You can answer a call by simply lifting the handset, or you can use other options if they are available on your phone.

If you want to...	Then...	For more information, see...
Answer with a headset	Press  , if unlit. Or, if  is lit, press Answer or  .	Using a Handset, Headset, and Speakerphone, page 32
Answer with the speakerphone	Press  , Answer , or  .	Using a Handset, Headset, and Speakerphone, page 32
Switch from a connected call to answer a ringing call	Press Answer or, if the call is ringing on a different line, press  for the appropriate line.	Using Hold and Resume, page 16
Answer using call waiting	Press Answer .	Using Hold and Resume, page 16
Auto-connect calls	Use AutoAnswer.	Using AutoAnswer with a Headset or Speakerphone, page 33
Retrieve a parked call on another phone	Use Call Park.	Storing and Retrieving Parked Calls, page 28
Use your phone to answer a call ringing elsewhere	Use Call Pickup.	Picking Up Redirected Calls on Your Phone, page 25
Answer a priority call	Hang up the current call and press Answer .	Prioritizing Critical Calls, page 30

Ending a Call

To end a call, simply hang up. Here are some more details.

If you want to...	Then...
Hang up while using the handset	Return the handset to its cradle. Or press EndCall .
Hang up while using a headset	Press  . Or, to keep headset mode active, press EndCall .
Hang up while using the speakerphone	Press  or EndCall .
Hang up one call, but preserve another call on the same line	Press EndCall . If necessary, remove the call from hold first.

Using Hold and Resume

You can hold and resume calls.



If you want to...	Then...
Put a call on hold	<ol style="list-style-type: none">1. Make sure the call you want to put on hold is highlighted.2. Press Hold.
Remove a call from hold on the current line	<ol style="list-style-type: none">1. Make sure the appropriate call is highlighted.2. Press Resume.
Remove a call from hold on a different line	Press  for the appropriate line. If a single call is holding on this line, the call automatically resumes. If multiple calls are holding, scroll to the appropriate call and press Resume .

Tips

- Engaging the Hold feature typically generates music or a beeping tone.
- A held call is indicated by the call-on-hold icon: 



Using Mute

With Mute enabled, you can hear other parties on a call but they cannot hear you. You can use mute in conjunction with the handset, speakerphone, or a headset.

If you want to...	Then...
Toggle Mute on	Press  .
Toggle Mute off	Press  .

Switching Between Multiple Calls

You can switch between multiple calls on one or more lines. If the call that you want to switch to is not automatically highlighted, use the Navigation button to scroll to it.

If you want to...	Then...
Switch between connected calls on one line	<ol style="list-style-type: none"> 1. Make sure the call that you want to switch to is highlighted. 2. Press Resume. Any active call is placed on hold and the selected call is resumed.
Switch between connected calls on different lines	Press  for the line that you are switching to. If a single call is holding on the line, the call automatically resumes. If multiple calls are holding, highlight the appropriate call and press Resume .
Switch from a connected call to answer a ringing call	Press Answer or, if the call is ringing on a different line, press  for the line that you want to switch to. Any active call is placed on hold and the selected call is resumed.







Viewing Multiple Calls

Understanding how multiple calls are displayed on your phone can help you organize your call-handling efforts.

In standard viewing mode, your phone displays calls as follows for the highlighted line:

- Calls with the highest precedence and longest duration display at the top of the list.
- Calls of a similar type are grouped together. For example, calls that you have interacted with are grouped near the top, and calls on hold grouped last.

You can use these additional methods to view multiple calls on multiple lines:

If you want to...	Then...
View calls on another line	Press  or  . Immediately press the line button  .
Switch to call overview mode	Press  for the highlighted line. The phone switches to call overview mode, displaying only one call per line. The displayed call is either the active call or the held call with the longest duration. To return to standard viewing mode, press  or  , then immediately press the line button.

Transferring Calls

Transfer redirects a connected call. The *target* is the number to which you want to transfer the call.

If you want to...	Then...
Transfer a call without talking to the transfer recipient	<ol style="list-style-type: none">1. From an active call, press Transfer.2. Enter the target number.3. Press Transfer again to complete the transfer or EndCall to cancel. <p>Note If your phone supports on-hook transfer, you can alternately complete the transfer by hanging up.</p>
Talk to the transfer recipient before transferring a call (consult transfer)	<ol style="list-style-type: none">1. From an active call, press Transfer.2. Enter the target number.3. Wait for the transfer recipient to answer.4. Press Transfer again to complete the transfer or EndCall to cancel. <p>Note If your phone supports on-hook transfer, you can alternately complete the transfer by hanging up.</p>
Transfer two current calls to each other (direct transfer) without staying on the line	<ol style="list-style-type: none">1. Scroll to highlight any call on the line.2. Press Select.3. Repeat this process for the second call.4. With one of the selected calls highlighted, press DirTrfr. (To display DirTrfr, you might need to press more.) <p>The two calls connect to each other and drop you from the call.</p> <p>Note If you want to stay on the line with the callers, use Join instead.</p>
Redirect a call to your voice messaging system	Press iDivert . The call is automatically transferred to your voice message greeting. You can use iDivert with a call that is active, ringing, or on hold.

Tips

- If on-hook transfer is enabled on your phone, you can either hang up to complete the call, or press **Transfer** and then hang up.
- If on-hook transfer is *not* enabled on your phone, hanging up without pressing **Transfer** again places the call on hold.
- You cannot use **Transfer** to redirect a call on hold. Press **Resume** to remove the call from hold before transferring it.

Forwarding Calls to Another Number

You can use the call forwarding features to redirect incoming calls from your phone to another number.

Your system administrator might allow you to choose from two types of call forwarding features:

- Unconditional call forwarding (Call Forward All)—Applies to all calls that you receive.
- Conditional call forwarding (Call Forward No Answer, Call Forward Busy, Call Forward No Coverage)—Applies to certain calls that you receive, according to conditions.

You can access Call Forward All on your phone or from your User Options web pages; conditional call forwarding features are accessible only from your User Options web pages. Your system administrator determines which call forwarding features are available to you.

If you want to...	Then...
Set up Call Forward All on your primary line	Press CFwdALL or Forward All and enter a target phone number.
Cancel Call Forward All on your primary line	Press CFwdALL or Forward All .
Verify that Call Forward All is enabled on your primary line	Look for: <ul style="list-style-type: none"> • The call forward icon above your primary phone number:  • The call forwarding target number in the status line.
Set up or cancel call forwarding remotely, or for a non-primary line	<ol style="list-style-type: none"> 1. Log in to your User Options web pages. (See the “Accessing Your User Options Web Pages” section on page 41.) 2. Access your call forwarding settings. (See the “Controlling Line Settings on the Web” section on page 47.) <p>Note When call forwarding is enabled for any line other than the primary line, your phone does not provide you with confirmation that calls are being forwarded. Instead, you must confirm your settings in the User Options web pages.</p>

Tips

- Enter the call forward target number exactly as you would dial it from your phone. For example, enter an access code or the area code, if necessary.
- You can forward your calls to a traditional analog phone or to another IP phone, although your system administrator might restrict the call forwarding feature to numbers within your company.
- Call forwarding is phone line specific. If a call reaches you on a line where call forwarding is not enabled, the call will ring as usual.

- Your system administrator can enable a call forward override feature that allows the person receiving your forwarded calls to reach you. With override enabled, a call placed from the target phone to your phone is not forwarded, but rings through.
- Your phone may reject your attempt to set up Call Forward All directly on the phone if the target number that you enter would create a call forwarding loop or would exceed the maximum number of links permitted in a call forwarding chain.

Making Conference Calls

Your Cisco Unified IP Phone allows you to join three or more people into one telephone conversation, creating a conference call.

Understanding Types of Conference Calls

There are two types of conference calls: Standard and Meet-Me.

Standard Conference Calls

You can create a standard conference in different ways, depending on your needs and the softkeys available on your phone:

- **Confrn**—Use this softkey to establish a standard conference by calling each participant. Standard conference calling is a default feature available on most phones.
- **Join**—Use this softkey to establish a standard conference by joining several calls already on one line.
- **cBarge**—Use this softkey to add yourself to an existing call on a shared line and to turn the call into a standard conference call. This feature is available only on phones that use shared lines.

See the [“Starting and Joining a Standard Conference” section on page 21](#) for additional instructions.

Meet-Me Conference Calls





You can create a Meet-Me conference by calling the Meet-Me phone number at a specified time.

See the [“Starting or Joining a Meet-Me Conference Call” section on page 23](#) for additional instructions.

Starting and Joining a Standard Conference

A standard conference allows at least three participants to talk on a single call.

If you want to...	Then...
<ul style="list-style-type: none"> • Create a conference by calling participants • Add new participants to an existing conference 	<ol style="list-style-type: none"> 1. From a connected call, press Confrn. (You may need to press the more softkey to see Confrn.) 2. Enter the participant's phone number. 3. Wait for the call to connect. 4. Press Confrn again to add the participant to your call. 5. Repeat to add additional participants. <p>Check with your system administrator to see if non-initiators of a conference can add or remove participants.</p>
<p>Create a conference by joining two or more existing calls</p>	<ol style="list-style-type: none"> 1. Make sure that you have two or more calls on a single line. 2. Highlight a call that you want to add to the conference. 3. Press Select. The selected call displays this icon . 4. Repeat this process for each call that you want to add. 5. From one of the selected calls, press Join. (You may need to press the more softkey to see Join.) <p>Note The active call is automatically selected.</p>
<p>Participate in a conference</p>	<p>Answer the phone when it rings.</p>
<p>Create a conference by barging a call on shared line</p>	<p>Highlight a call on a shared line and press cBarge. (You may need to press the more softkey to display cBarge.)</p> <p>See the “Using a Shared Line” section on page 26.</p>
<p>View a list of conference participants</p>	<ol style="list-style-type: none"> 1. Highlight an active conference. 2. Press ConfList. Participants are listed in the order in which they join the conference with the most recent additions at the top.
<p>Get an updated list of participants</p>	<p>While viewing the conference list, press Update.</p>
<p>See who started the conference</p>	<p>While viewing the conference list, locate the person listed at the bottom of the list with an asterisk (*) next to the name.</p>
<p>Drop the last party added to the conference</p>	<p>Press RmLstC. You can remove participants only if you initiated the conference call.</p>

If you want to...	Then...
Remove any conference participant	<ol style="list-style-type: none"> 1. Highlight the participant's name. 2. Press Remove. <p>You can remove participants only if you initiated the conference.</p>
End your participation in a conference	Hang up or press EndCall .
Join together two standard conferences on the same line	<p>On SCCP phones, use the Join or DirTrfr softkeys.</p> <p>On SIP phones, use the Conf or Transfer softkeys.</p> <p>Check with your system administrator to see if this feature is available to you.</p>
Verify that a conference call is secure	Look for the  or  icon after “Conference” on the phone screen.
Remove a non-secure participant from a conference	<p>While viewing the Conference List, locate the participant without the  or  icon, and press Remove.</p> <p>Check with your system administrator to see if non-initiators of a conference can remove participants.</p>

Tips

- To start a secure conference, you must use a phone configured with security.
- Non-secure conferences and participants display a  icon.
- Calls must be on the same line before you can add them to a conference. If calls are on different lines, transfer them to a single line before using **Confrn** or **Join**.
- Depending on how your phone is configured, if you leave a conference after creating it, the conference might end. To avoid this, transfer the conference before hanging up.

Starting or Joining a Meet-Me Conference Call

Meet-Me conferencing allows you to start or join a conference by dialing the conference number.

If you want to...	Then...
Start a Meet-Me conference	<ol style="list-style-type: none"> 1. Obtain a Meet-Me phone number from your system administrator. 2. Distribute the number to participants. 3. When you are ready to start the meeting, go off-hook to invoke a dial tone, then press MeetMe. 4. Dial the Meet-Me conference number. Participants can now join the conference by dialing in. <p>Note Participants hear a busy tone if they call the conference before the initiator has joined. In this case, participants must call back.</p>
Join a Meet-Me conference	<p>Dial the Meet-Me conference number (provided by the conference initiator).</p> <p>Note You will hear a busy tone if you call the conference before the initiator has joined. In this case, try your call again.</p>
End a Meet-Me conference	<p>All participants must hang up. The conference does not automatically end when the conference initiator disconnects.</p>

Advanced Call Handling

Advanced call-handling tasks involve special features that your system administrator might configure for your phone depending on your call-handling needs and work environment.

Speed Dialing

Speed dialing allows you to enter an index number, press a button, or select a phone screen item to place a call. Depending on configuration, your phone can support several speed-dial features:

- Speed-dial buttons
- Abbreviated Dialing
- Fast Dials



- Note**
- To set up speed-dial buttons and Abbreviated Dial, you must access your User Options web pages. See the [“Accessing Your User Options Web Pages”](#) section on page 41.
 - To set up Fast Dials, you must have access to the Personal Directory feature. See [“Using Personal Directory on the Web”](#) section on page 42.
 - Alternately, your system administrator can configure speed-dial features for you.

If you want to...	Then...
Use speed-dial buttons	<ol style="list-style-type: none">1. Set up speed-dial buttons. See the “Setting Up Speed Dials on the Web” section on page 44.2. To place a call, press  (a speed-dial button). <p>Note If your phone supports the Busy Lamp Field (BLF) feature, you can see if the speed-dial number is busy before dialing. See the Using BLF to Determine a Line State, page 31.</p>
Use Abbreviated Dial	<ol style="list-style-type: none">1. Set up Abbreviated Dialing codes. See the “Setting Up Speed Dials on the Web” section on page 44.2. To place a call, enter the Abbreviated Dialing code and press AbbrDial.
Use Fast Dial	<ol style="list-style-type: none">1. Create a Personal Address Book entry and assign a Fast Dials code. See the “Using Personal Directory on the Web” section on page 42.2. To place a call, access the Fast Dial service on your phone. See the “Using Personal Directory on the Web” section on page 42.

Picking Up Redirected Calls on Your Phone

Call PickUp allows you to answer a call that is ringing on a co-worker's phone by redirecting the call to your phone. You might use Call PickUp if you share call-handling with co-workers.

If you want to...	Then...
Answer a call that is ringing on another extension within your call pickup group	<ol style="list-style-type: none"> Do one of the following: <ul style="list-style-type: none"> If the PickUp softkey is available, press it. If the PickUp softkey is not available, go off-hook to display it, then press PickUp. <p>If your phone supports auto-pickup, you are now connected to the call.</p> If the call rings, press Answer to connect to the call.
Answer a call that is ringing on another extension outside of your group	<ol style="list-style-type: none"> Do one of the following: <ul style="list-style-type: none"> If the GPickUp softkey is available, press it. If the GPickUp softkey is not available, go off-hook to display it, then press GPickUp. Enter the group pickup code. <p>If your phone supports auto-pickup, you are now connected to the call.</p> If the call rings, press Answer to connect to the call.
Answer a call that is ringing on another extension in your group or in an associated group	<ol style="list-style-type: none"> Do one of the following: <ul style="list-style-type: none"> If the OPickUp softkey is available, press it. If the OPickUp softkey is not available, go off-hook to display it, then press OPickUp. <p>If your phone supports auto-pickup, you are now connected to the call.</p> If the call rings, press Answer to connect to the call.

Tips

- Pressing **PickUp** and **GPickUp** connects to the call that has been ringing for the longest time.
- Pressing **OPickUp** connects you to the call in the pickup group with the highest priority.
- If you have multiple lines and want to pick up the call on a non-primary line, first press  for the desired line, then press a Call PickUp softkey.

Using a Shared Line

Your system administrator might ask you to use a shared line if you:

- Have multiple phones and want one phone number
- Share call-handling tasks with co-workers
- Handle calls on behalf of a manager

Understanding Shared Lines

Remote-in-Use Icon

The remote-in-use icon  appears when another phone that shares your line has a connected call. You can place and receive calls as usual on the shared line, even when the remote-in-use icon appears.

Sharing Call Information and Barging

Phones that share a line each display information about calls that are placed and received on the shared line. This information might include caller ID and call duration. (See the [Privacy](#) section for exceptions.)

When call information is visible in this way, you and coworkers who share a line can add yourselves to calls using either **Barge** or **cBarge**. See the [“Adding Yourself to a Shared-Line Call”](#) section on [page 27](#).

Privacy

If you do not want coworkers who share your line to see information about your calls, enable the Privacy feature. Doing so also prevents co-workers from barging your calls. See the [“Preventing Others from Viewing or Barging a Shared-Line Call”](#) section on [page 28](#).



Note

The maximum number of calls that a shared line supports can vary by phone.

Adding Yourself to a Shared-Line Call

Depending on how your phone is configured, you can add yourself to a call on a shared line using either **Barge** or **cBarge**.







If you want to...	Then...
See if the shared line is in use	Look for the remote-in-use icon  .
Add yourself to a call on a shared line using the Barge softkey	<ol style="list-style-type: none"> 1. Highlight a remote-in-use call. 2. Press Barge. (You may need to press the more softkey to display Barge.) Other parties hear a beep tone announcing your presence.
Add yourself to a call on a shared line using the cBarge softkey	<ol style="list-style-type: none"> 1. Highlight a remote-in-use call. 2. Press cBarge. (You may need to press the more softkey to display cBarge.) Other parties hear a tone and brief audio interruption, and call information changes on the phone screen.
Add new conference participants to a call that you have barged	<p>Barge the call using cBarge, if available.</p> <p>Unlike Barge, cBarge converts the call into a standard conference call, allowing you to add new participants. See the “Making Conference Calls” section on page 20.</p>
Leave a barged call	<p>Hang up.</p> <p>If you hang up after using Barge, the remaining parties hear a disconnect tone and the original call continues.</p> <p>If you hang up after using cBarge, the call remains a conference call (provided at least three participants remain on the line).</p>

Tips

- If a phone that is using the shared line has Privacy enabled, call information and barge softkeys will not appear on the other phones that share the line.
- You will be disconnected from a call that you have joined using **Barge** if the call is put on hold, transferred, or turned into a conference call.

Preventing Others from Viewing or Barging a Shared-Line Call

If you share a phone line, you can use the Privacy feature to prevent others who share the line from viewing or barging (adding themselves to) your calls.

If you want to...	Then...
Prevent others from viewing or barging calls on a shared line	<ol style="list-style-type: none">1. Press Private .2. To verify that Privacy is on, look for the feature-enabled icon  next to the line button .
Allow others to view or barge calls on a shared line	<ol style="list-style-type: none">1. Press Private .2. To verify that Privacy is off, look for the feature-disabled icon  next to the line button .

Tips

- If the phone that shares your line has Privacy enabled, you can make and receive calls using the shared line as usual.
- The Privacy feature applies to all shared lines on your phone. Consequently, if you have multiple shared lines and Privacy is enabled, coworkers will not be able to view or barge calls on any of your shared lines.

Storing and Retrieving Parked Calls

You can park a call when you want to store the call so that you or someone else can retrieve it from another phone in the Cisco Unified Communications Manager system (for example, a phone at a co-worker's desk or in a conference room).

If you want to...	Then...
Store an active call using Call Park	<ol style="list-style-type: none">1. During a call, press Park. (You may need to press the more softkey to see Park.)2. Note the call park number displayed on your phone screen.3. Hang up.
Retrieve a parked call	Enter the call park number from any Cisco Unified IP Phone in your network to connect to the call.





Note You have a limited amount of time to retrieve a parked call before it reverts to ringing at the original number. See your system administrator for details.

Making and Receiving Secure Calls

Depending on how your system administrator has configured your phone system, your phone might support making and receiving secure calls.

Your phone is capable of supporting these types of calls:

- *Authenticated* call—The identities of all phones participating in the call have been verified.
- *Encrypted* call—The phone is receiving and transmitting encrypted audio (your conversation) within the Cisco Unified IP network. Encrypted calls are also authenticated.
- *Non-secure* call—At least one of the participating phones or the connection does not support these security features, or the phones cannot be verified.

If you want to...	Then...
Check the security level of a call or conference	Look for a security icon in the top right corner of the call activity area, next to the call duration timer: <ul style="list-style-type: none">  Authenticated call  Encrypted call Neither security icon appears if the call is non-secure.
Determine if secure calls can be made in your company	Contact your system administrator.



Note There are interactions, restrictions, and limitations that affect how security features work on your phone. For more information, ask your system administrator.

Tracing Suspicious Calls

If you are receiving suspicious or malicious calls, your system administrator can add the Malicious Call Identification (MCID) feature to your phone. This feature enables you to identify an active call as suspicious, which initiates a series of automated tracking and notification messages.





If you want to...	Then...
Notify your system administrator about a suspicious or harassing call	Press MCID . Your phone plays a tone and displays the message, “MCID successful.”

Prioritizing Critical Calls

In some specialized environments, such as military or government offices, you might need to make and receive urgent or critical calls. If you have the need for this specialized call handling, your system administrator can add Multilevel Precedence and Preemption (MLPP) to your phone.

Keep these terms in mind:

- *Precedence* indicates the priority associated with a call.
- *Preemption* is the process of ending an existing, lower priority call while accepting a higher priority call that is sent to your phone.



If you...	Then...
Want to choose a priority (precedence) level for an outgoing call	Contact your system administrator for a list of corresponding precedence numbers for calls.
Want to make a priority (precedence) call	Enter the MLPP access number (provided by your system administrator) followed by the phone number.
Hear a special ring (faster than usual) or special call waiting tone	You are receiving a priority (precedence) call. An MLPP icon on your phone screen indicates the priority level of the call.
Want to view priority level of a call	Look for an MLPP icon on your phone screen: <ul style="list-style-type: none"> Priority call Medium priority (immediate) call High priority (flash) call Highest priority (flash override) or Executive Override call Higher priority calls are displayed at the top of your call list. If you do not see an MLPP icon, the priority level of the call is normal (routine).
Want to accept a higher-priority call	Answer the call as usual. If necessary, end an active call first.
Hear a continuous tone interrupting your call	You or the other party are receiving a call that must preempt the current call. Hang up immediately to allow the higher priority call to ring through.

Tips

- When you make or receive an MLPP-enabled call, you will hear special ring tones and call waiting tones that differ from the standard tones.
- If you enter an invalid MLPP access number, a verbal announcement will alert you of the error.
- Multilevel Precedence and Preemption (MLPP) overrides the Do Not Disturb (DND) feature.

Using Cisco Extension Mobility

Cisco Extension Mobility (EM) allows you to temporarily configure a Cisco Unified IP Phone as your own. Once you log in to EM, the phone adopts your user profile, including your phone lines, features, established services, and web-based settings. Your system administrator must configure EM for you.



If you want to...	Then...
Log in to EM	<ol style="list-style-type: none"> 1. Choose  > EM Service (name can vary). 2. Enter your user ID and PIN (provided by your system administrator). 3. If prompted, select a device profile.
Log out of EM	<ol style="list-style-type: none"> 1. Choose  > EM Service (name can vary). 2. When prompted to log out, press Yes.

Tips

- EM automatically logs you out after a certain amount of time. Your system administrators establishes this time limit. \
- Changes that you make to your EM profile from your User Options web pages take effect immediately if you are logged in to EM on the phone; otherwise, changes take effect the next time you log in.
- Changes that you make to the phone from your User Options web pages take effect immediately if you are logged out of EM; otherwise, changes take effect after you log out.
- Local settings controlled by the phone are not maintained in your EM profile.

Using BLF to Determine a Line State

Depending on configuration, you can use the Busy Lamp Field (BLF) feature to determine the state of a phone line associated with a speed-dial button on your phone. You can place a call to this line, regardless of the BLF status. This feature does not prevent dialing.

If you want to...	Then...
See the state of a speed-dial line	Look for one of these indicators next to the line number: <ul style="list-style-type: none">  Line is in-use. Line is idle.  BLF indicator unavailable for this line.



Using a Handset, Headset, and Speakerphone

You can use your phone with these audio devices: a handset, headset, or speakerphone.

The phone is off-hook when the handset is lifted or another audio device is in use.



The phone is on-hook when the handset is in its cradle and other audio devices are not in use.



Using a Handset

If you want to...	Then...
Go off-hook	Lift the handset.
Go on-hook	Replace the handset in the cradle.
Switch to the speakerphone or headset during	Press  or  , then hang up the handset.
Adjust the volume level for a call	Press  during a call or after invoking a dial tone. Press Save to preserve the volume level for future calls.

Using a Headset

Your phone supports four- or six-wire headset jacks for wired headsets. For information about purchasing headsets, see [Headset Support, page 5](#).



You can use a headset in conjunction with all of the controls on your phone, including  and .

If you want to...	Then...
Toggle headset mode on and off	Press  .
Switch to a handset	Lift the handset.
Adjust the volume level for a call	Press  during a call or after invoking a dial tone. Press Save to preserve the volume level for future calls.

If you use AutoAnswer, see [Using AutoAnswer with a Headset or Speakerphone, page 33](#).



Using a Speakerphone

Many of the actions you can take to dial a number or answer a call will automatically trigger speakerphone mode, assuming that the handset is in its cradle and  is not lit.

If you want to...	Then...
Toggle speakerphone mode on or off	Press  to
Switch to a handset	Lift the handset.
Adjust the volume level for a call	Press  during a call or after invoking a dial tone. Press Save to preserve the volume level for future calls.

Using AutoAnswer with a Headset or Speakerphone

When AutoAnswer is enabled, your phone answers incoming calls automatically after a few rings. Your system administrator configures AutoAnswer to use either the speakerphone or a headset. You might use AutoAnswer if you receive a high volume of incoming calls.



If you...	Then...
Use AutoAnswer with a headset	<p>Keep headset mode active (in other words, keep  illuminated), even when you are not on a call.</p> <p>To keep headset mode active, do the following:</p> <ul style="list-style-type: none"> • Press EndCall to hang up. • Press New Call or Dial to place new calls. <p>If your phone is set up to use AutoAnswer in headset mode, calls are automatically answered only if  is illuminated.</p> <p>Otherwise, calls ring normally and you must manually answer them.</p>
Use AutoAnswer with the speakerphone	<p>Keep the handset in the cradle and headset mode inactive ( unlit).</p> <p>Otherwise, calls ring normally and you must manually answer them.</p>

Using Phone Settings

You can personalize your Cisco Unified IP Phone by adjusting the ring tone, background image, and other settings.









Customizing Rings and Message Indicators

You can customize how your phone indicates an incoming call and a new voice mail message. You can also adjust the ringer volume for your phone.

If you want to...	Then...
Change the ring tone per line	<ol style="list-style-type: none">1. Choose  > Ring Type.2. Choose a phone line or the default ring setting.3. Choose a ring tone to play a sample of it.4. Press Select and OK to set the ring tone, or press Cancel.
Change the ring pattern per line (flash-only, ring once, beep-only, etc.)	<ol style="list-style-type: none">1. Log in to your User Options web pages. (See the “Accessing Your User Options Web Pages” section on page 41.)2. Access your call ring pattern settings. (See the “Controlling Line Settings on the Web” section on page 47.) <p>Note Before you can access this setting, your system administrator might need to enable it for you.</p>
Adjust the volume level for the phone ringer	Press  while the handset is in the cradle and the headset and speakerphone buttons are off. The new ringer volume is saved automatically.
Change the way that the voice message light on your handset works	<ol style="list-style-type: none">1. Log in to your User Options web pages. (See the “Accessing Your User Options Web Pages” section on page 41.)2. Access your message indicator settings. (See the “Controlling Line Settings on the Web” section on page 47.) <p>Note Typically, the default system policy is to indicate a new voice message by displaying a steady light on the handset light strip.</p>

Customizing the Phone Screen

You can adjust the characteristics of your phone screen.





If you want to...	Then...
Change the phone screen brightness	<ol style="list-style-type: none"> 1. Choose  > Brightness. 2. To make adjustments, press Up, Down or . 3. Press Save, or press Cancel.
Adjust the phone screen to accommodate your viewing angle	<ol style="list-style-type: none"> 1. Choose  > Viewing Angle. 2. To make adjustments, press Up, Down or . 3. Press Save, or press Cancel.
Change the background image	<ol style="list-style-type: none"> 1. Choose  > Background Images. 2. Scroll through available images and press Select to choose an image. 3. Press Preview to see a larger view of the background image. 4. Press Exit to return to the selection menu. 5. To make adjustments, press Up, Down or . 6. Press Save to accept the new image, or press Cancel.
Change the language on your phone screen	<ol style="list-style-type: none"> 1. Log in to your User Options web pages. (See the “Accessing Your User Options Web Pages” section on page 41.) 2. Access your user settings. (See the “Controlling Line Settings on the Web” section on page 47.)
Change the line text label	<ol style="list-style-type: none"> 1. Log in to your User Options web pages. (See the “Accessing Your User Options Web Pages” section on page 41.) 2. Access your line label settings. (See the “Controlling Line Settings on the Web” section on page 47.)
Adjust contrast for your Cisco Unified IP Phone Expansion Module 7914 (if applicable)	<ol style="list-style-type: none"> 1. Choose  > Contrast. 2. To make adjustments, press Up, Down or . 3. Press Save, or press Cancel.

Using Call Logs and Directories

This section describes how you can use call logs and directories. To access both features, use the Directories button .

Using Call Logs

Your phone maintains records of your missed, placed, and received calls.

If you want to...	Then...
View your call logs	Choose  > Missed Calls , Placed Calls , or Received Calls . Each stores up to 32 records. To view a truncated listing, highlight it and press EditDial .
Erase your call logs	Press  , then press Clear . Doing so erases all records in all logs.
Dial from a call log (while not on another call)	<ol style="list-style-type: none">1. Choose  > Missed Calls, Placed Calls, or Received Calls.2. Select the listing or scroll to it.3. If you need to edit the number, press EditDial followed by << or >>. To delete the number, press EditDial followed by Delete. (You may need to press the more softkey to display Delete.)4. Go off-hook to place the call.
Dial from a call log (while connected to another call)	<ol style="list-style-type: none">1. Choose  > Missed Calls, Placed Calls, or Received Calls.2. Select the listing or scroll to it.3. If you need to edit the number, press EditDial followed by << or >>. To delete the number, press EditDial followed by Delete. (You may need to press the more softkey to display Delete.)4. Press Dial.5. Choose a menu item to handle the original call:<ul style="list-style-type: none">• Hold—Puts the first call on hold and dials the second.• Transfer—Transfers the first party to the second and drops you from the call. (Press Transfer again after dialing to complete the action.)• Conference—Creates a conference call with all parties, including you. (Press Confrn again after dialing to complete the action.)• End Call—Disconnects the first call and dials the second.



Directory Dialing

Depending on configuration, your phone can provide corporate and personal directory features:

- **Corporate Directory**—Corporate contacts that you can access on your phone. Corporate Directory is set up and maintained by your system administrator.
- **Personal Directory**—If available, personal contacts and associated speed-dial codes that you can configure and access from your phone and User Options web pages. Personal Directory is comprised of Personal Address Book (PAB) and Fast Dials.
 - PAB is a directory of your personal contacts.
 - Fast Dials allows you to assign codes to PAB entries for quick dialing.

Using Corporate Directory on Your Phone

You can use a corporate directory to place calls to coworkers.

If you want to...	Then...
Dial from a corporate directory (while not on another call)	<ol style="list-style-type: none"> 1. Choose  > Corporate Directory (exact name can vary). 2. Use your keypad to enter a full or partial name and press Search. 3. To dial, press the listing, or scroll to the listing and go off-hook.
Dial from a corporate directory (while on another call)	<ol style="list-style-type: none"> 1. Choose  > Corporate Directory (exact name can vary). 2. Use your keypad to enter a full or partial name and press Search. 3. Scroll to a listing and press Dial. 4. Choose a menu item to handle the original call: <ul style="list-style-type: none"> • Hold—Puts the first call on hold and dials the second. • Transfer—Transfers the first party to the second and drops you from the call. (Press Transfer again after dialing to complete the action.) • Confrn—Creates a conference call with all parties, including you. (Press Confrn again after dialing to complete the action.) • End Call—Disconnects the first call and dials the second.



Tip

Use the numbers on your keypad to enter characters on your phone screen. Use the Navigation button on your phone to move between input fields.

Using Personal Directory on Your Phone

The Personal Directory feature set contains your Personal Address Book (PAB) and Fast Dials. This section describes how to set up and use Personal Directory on your phone. Alternately, see the [“Using Personal Directory on the Web” section on page 42.](#)

If you want to...	Then...
Access Personal Directory (for PAB and Fast Dial codes)	<ol style="list-style-type: none"> 1. Choose  > Personal Directory (exact name can vary). 2. Enter your Cisco Unified Communications Manager user ID and PIN, then press Submit.
Search for a PAB entry	<ol style="list-style-type: none"> 1. Access Personal Directory, then choose Personal Address Book. 2. Enter search criteria and press Submit. 3. You can choose Previous or Next to move through listings. 4. Highlight the PAB listing that you want and press Select.
Dial from PAB entry	<ol style="list-style-type: none"> 1. Search for a listing. 2. Highlight the listing and press Select. 3. Press Dial. (You may need to press the more softkey to see Dial.) 4. Enter the participant’s phone number 5. Highlight the number that you want to dial and press OK. 6. Press OK again to dial the number.
Delete a PAB entry	<ol style="list-style-type: none"> 1. Search for a listing. 2. Highlight the listing and press Select. 3. Press Delete. 4. Choose OK to confirm the deletion.
Edit a PAB entry	<ol style="list-style-type: none"> 1. Search for a listing. 2. Highlight the listing and press Edit to modify a name or mail address. 3. If necessary, choose Phones to modify a phone number. 4. Press Update.
Add a new PAB entry	<ol style="list-style-type: none"> 1. Access Personal Directory, then choose Personal Address Book. 2. Access the Search page by choosing Submit. (you do not need to input search information first.) 3. Press New. 4. Use your phone keypad to enter a name and email information. 5. Choose Phones and use the keypad to enter phone numbers. Be sure to include any necessary access codes such as a 9 or 1. 6. Choose Submit to add the entry to the database.

If you want to...	Then...
Assign a Fast Dial code to a PAB entry	<ol style="list-style-type: none"> 1. Search for a PAB entry. 2. Highlight the listing and press Select. 3. Press Fast Dial. 4. Highlight the number that you want to dial and press Select. 5. Highlight the Fast Dial code that you want to assign to the number and press Select.
Add a new Fast Dial code (not using a PAB entry)	<ol style="list-style-type: none"> 1. Choose  > Personal Directory > Personal Fast Dials. 2. Press Fast Dial. 3. Highlight a Fast Dial code that is unassigned and press Select. 4. Press Assign. 5. Enter a phone number. 6. Press Update.
Search for Fast Dial codes	<ol style="list-style-type: none"> 1. Choose  > Personal Directory > Personal Fast Dials. 2. You can choose Previous or Next to move through listings. 3. Highlight the listing that you want and press Select.
Place a call using a Fast Dial code	<ol style="list-style-type: none"> 1. Search for a Fast Dial code. 2. Highlight the listing you want and press Select. 3. Press Dial. 4. Choose OK to complete the action.
Delete a Fast Dial code	<ol style="list-style-type: none"> 1. Search for a Fast Dial code. 2. Highlight the listing you want and press Select. 3. Press Remove.
Log out of Personal Directory	<ol style="list-style-type: none"> 1. Choose  > Personal Directory (exact name may vary). 2. Choose Logout.

Tips



- Your system administrator can provide you the user ID and PIN that you need to log in to Personal Directory.
- Personal Directory automatically logs you out after a certain amount of time. This time limit can vary. Ask your system administrator for more information.
- Use the numbers on your keypad to enter characters on your phone screen. Use the Navigation button on your phone to move between input fields.

Accessing Voice Messages

To access voice messages, use the Messages button .



Note Your company determines the voice message service that your phone system uses. For the most accurate and detailed information, refer to the documentation that came with your voice message service.

If you want to...	Then...
Set up and personalize your voice message service	Press  and follow the voice instructions. If a pop-up messages menu appears on your phone screen, choose an appropriate menu item.
See if you have a new voice message	Look for: <ul style="list-style-type: none"><li data-bbox="377 708 1190 764">• A steady red light on your handset. (This indicator can vary. See the “Customizing Rings and Message Indicators” section on page 34.)<li data-bbox="377 773 1190 805">• A message waiting icon  and text message on your phone screen.
Listen to your voice messages or access the voice messages menu	Press  . Depending on your voice message service, doing so either auto-dials your voice message service or provides a menu on your phone screen.

Customizing Your Phone on the Web

Your Cisco Unified IP Phone is a network device that can share information with other network devices in your company, including your personal computer. You can use your computer to log in to your Cisco Unified Communications Manager User Options web pages, where you can control features, settings, and services for your Cisco Unified IP Phone. For example, you can set up speed-dial buttons from your User Options web pages.

Accessing Your User Options Web Pages

This section describes how to log in and select a phone device.

If you want to...	Then do this...
Log in to your User Options web pages	<ol style="list-style-type: none"> 1. Obtain a User Options URL, user ID, and default password from your system administrator. 2. Open a web browser on your computer, enter the URL, and log on. 3. If prompted to accept security settings, click Yes or Install Certificate. <p>The Cisco Unified CM User Options main web page displays. From this page you can choose User Options to access User Settings, Directory features, a Personal Address Book, and Fast Dials.</p> <p>Or, to access phone-specific options, select a device (see below).</p>
Select a device after logging in	<ol style="list-style-type: none"> 1. After you have logged in to your User Options web pages, choose User Options > Device. <p>The Device Configuration page displays.</p> <ol style="list-style-type: none"> 2. If you have multiple devices assigned to you, verify that the appropriate device (phone model or Extension Mobility profile) is selected. If necessary, choose another device from the Name drop-down menu. <p>From the Device Configuration page, you can access all of the various configuration options available for your phone (other pages might not provide access to all options).</p> <ul style="list-style-type: none"> – Choose User Options to access User Settings, Directory, Personal Address Book, and Fast Dials. – Choose toolbar buttons to access phone-specific options, such as line settings, phone service settings, and speed dials. <p>To return to the Device Configuration page from another page, choose User Options > Device.</p>

Configuring Features and Services on the Web

The topics in this section describe how to configure features and services from your User Options web pages after logging in. See the [“Accessing Your User Options Web Pages”](#) section on page 41.

Using Personal Directory on the Web

The Personal Directory feature set that you can access on your computer consists of:

- A Personal Address Book (PAB)
- Fast Dials
- Cisco Unified Communications Manager Address Book Synchronizer



Note You can also access PAB and Fast Dials from your phone. See the [“Using Personal Directory on Your Phone”](#) section on page 38.

Using Your Personal Address Book on the Web

This section describes how to use your PAB from your User Options web pages.

If you want to...	Then do this after you log in...
Add a new PAB entry	<ol style="list-style-type: none">1. Choose User Options > Personal Address Book.2. Click New.3. Enter information for the entry.4. Click Save.
Search for a PAB entry	<ol style="list-style-type: none">1. Choose User Options > Personal Address Book.2. Specify search information and click Find.
Edit a PAB entry	<ol style="list-style-type: none">1. Search for a PAB entry.2. Click a name or nickname.3. Edit the entry as needed and click Save.
Delete a PAB entry	<ol style="list-style-type: none">1. Search for a PAB entry.2. Select one or more entries.3. Click Delete Selected.

Configuring Fast Dials on the Web

This section describes how to assign Fast Dials from your User Options web pages.

If you want to...	Then do this after you log in...
Assign a Fast Dial code to a PAB entry	<ol style="list-style-type: none"> 1. Create a PAB entry. See the “Using Your Personal Address Book on the Web” section on page 42. 2. Choose User Options > Fast Dials. 3. Click Add New. 4. Change the Fast Dial code, if desired. 5. Use the Search Options area to find the appropriate PAB entry. 6. Click a phone number in the Search Results area. 7. Click Save.
Assign a Fast Dial code to a phone number (without using a PAB entry)	<ol style="list-style-type: none"> 1. Choose User Options > Fast Dials. 2. Click Add New. 3. Change the Fast Dial code, if desired. 4. Enter a phone number. 5. Click Save.
Search for a Fast Dial entry	<ol style="list-style-type: none"> 1. Choose User Options > Fast Dials. 2. Specify search information and click Find.
Edit a Fast Dial phone number	<ol style="list-style-type: none"> 1. Choose User Options > Fast Dials. 2. Search for the Fast Dial entry that you want to edit. 3. Click on a component of the entry. 4. Change the phone number. 5. Click Save.
Delete a Fast Dial entry	<ol style="list-style-type: none"> 1. Search for a Fast Dial. 2. Select one or more entries. 3. Click Delete Selected.

Tips

- You can create up to 500 Fast Dial and PAB entries.
- You can create a new Fast Dial entry without using a PAB entry. Such Fast Dial entries are labeled “raw” in the User Options web pages and do not display a configurable text label.

Using the Address Book Synchronization Tool

You can use Cisco Unified Communications Manager Address Book Synchronizer to synchronize your existing Microsoft Windows Address Book (if applicable) with your PAB. Entries from your Microsoft Windows Address Book will then be accessible on your Cisco Unified IP Phone and User Options web pages. Your system administrator can give you access to Cisco Unified Communications Manager Address Book Synchronizer and provide detailed instructions.

Setting Up Speed Dials on the Web

Depending on configuration, your phone can support several speed-dial features:

- Speed-dial buttons
- Abbreviated Dialing
- Fast Dials



Note For help using speed-dial features, see the [“Speed Dialing”](#) section on page 24.



If you want to...	Then do this after you log in...
Set up speed-dial buttons	<ol style="list-style-type: none">1. Select a device.2. Click Speed Dials.3. Enter a number and label for a speed-dial button (programmable button) on your phone.4. Click Save. <p>Note Your phone uses the ASCII Label field if the phone does not support double-byte character sets.</p>
Set up Abbreviated Dialing	<ol style="list-style-type: none">1. Select a device.2. Click Speed Dials.3. Enter a number and label for an Abbreviated Dialing code.4. Click Save.
Set up Fast Dials	See the “Configuring Fast Dials on the Web” section on page 43. You can also set up Fast Dials on your phone. See the “Using Personal Directory on Your Phone” section on page 38.

Tip

You can set up a speed-dial button for each programmable button on your phone that is not reserved as line button. Alternately, use Abbreviated Dial or Fast Dial.

Setting Up Phone Services on the Web

Phone services can include special phone features, network data, and web-based information (such as stock quotes and movie listings). You must first subscribe to a phone service before accessing it on your phone.

If you want to...	Then do this after you log in...
Subscribe to a service	<ol style="list-style-type: none"> 1. Select a device. 2. Click Phone Services. 3. Click Add New. 4. Choose a service from the drop-down list and click Next. 5. Change the service label and/or enter additional service information, if available (optional). 6. Click Save.
Search for services	<ol style="list-style-type: none"> 1. Select a device. 2. Click Phone Services. 3. Click Find.
Change or end services	<ol style="list-style-type: none"> 1. Search for services. 2. Select one or more entries. 3. Click Delete Selected.
Change a service name	<ol style="list-style-type: none"> 1. Search for services. 2. Click on the service name. 3. Change the information and click Save.
Add a service to an available programmable phone button	<ol style="list-style-type: none"> 1. Select a device. 2. Click Service URL. <p>Note If you do not see this option, ask your system administrator to configure a service URL button for your phone.</p> <ol style="list-style-type: none"> 3. Choose a service from the Button Service drop-down list. 4. If you want to rename the service, edit the label fields. <p>Note Your phone uses the ASCII Label field if the phone does not support double-byte character sets.</p> <ol style="list-style-type: none"> 5. Click Save. 6. Click Reset to reset your phone (necessary to see the new button label on your phone).
Access a service on your phone	Press  on your phone. Or, if you have added a service to a programmable button  , press the button.

Controlling User Settings on the Web

User settings include your password, PIN, and language (locale) settings.

If you want to...	Then do this after you log in...
Change your password	<ol style="list-style-type: none">1. Choose User Options > User Settings.2. In the Browser Password area, enter information.3. Click Save.
Change your PIN	<ol style="list-style-type: none">1. Choose User Options > User Settings.2. In the Phone PIN area, enter information.3. Click Save.
Change the language (locale) for your User Options web pages	<ol style="list-style-type: none">1. Choose User Options > User Settings.2. In the User Locale area, choose an item from the Locale drop-down list.3. Click Save.
Change the language (locale) for your phone screen	<ol style="list-style-type: none">1. Go to the Device Configuration page by choosing User Options > Device.2. Choose an item from the User Locale drop-down list.3. Click Save.

Tip

Your PIN and password allow you to access different features and services. For example, use your PIN to log in to Cisco Extension Mobility or Personal Directory on your phone. Use your password to log in to your User Options web pages and Cisco WebDialer on your personal computer. For more information, ask your system administrator.

Controlling Line Settings on the Web

Line settings affect a specific phone line (directory number) on your phone. Line settings can include call-forwarding, voice message indicators, ring patterns, and line labels.



Note

- You can set up call forwarding (for your primary phone line) directly on your phone. See the [“Forwarding Calls to Another Number”](#) section on page 19.
- To learn about phone settings that you can access directly on your phone, see the [“Using Phone Settings”](#) section on page 34.

If you want to...	Then do this after you log in...
Set up call forwarding per line	<ol style="list-style-type: none"> 1. Select a device. 2. Click Line Settings. 3. If you have more than one directory number (line) assigned to your phone, verify that the appropriate line is selected or choose a new one. 4. In the Incoming Call Forwarding area, choose call forwarding settings for various conditions. 5. Click Save.
Change the voice message indicator setting per line	<ol style="list-style-type: none"> 1. Select a device. 2. Click Line Settings. 3. If you have more than one directory number (line) assigned to your phone, verify that the appropriate line is selected or choose a new one. 4. In the Message Waiting Lamp area, choose from various settings. <p>Note Typically, the default message waiting setting prompts your phone to display a steady red light from the handset light strip to indicate a new voice message.</p> <ol style="list-style-type: none"> 5. Click Save.

If you want to...	Then do this after you log in...
Change the ring pattern per line	<ol style="list-style-type: none"> 1. Select a device. 2. Click Line Settings. 3. If you have more than one directory number (line) assigned to your phone, verify that the appropriate line is selected or choose a new one. 4. In the Ring Settings area, choose a setting to tell your phone how to indicate an incoming call on the selected line. 5. Click Save. <p>Note The “idle” ring setting pertains if you receive an incoming call when the phone is idle. The “consecutive” ring setting pertains if you receive an incoming call when the phone is active.</p>
Change or create a line text label that appears on your phone screen	<ol style="list-style-type: none"> 1. Select a device. 2. Click Line Settings. 3. If you have more than one directory number (line) assigned to your phone, verify that the appropriate line is selected or choose a new one. 4. In the Line Text Label area, enter a text label. 5. Click Save. <p>Note Your phone uses the ASCII Label field if the phone does not support double-byte character sets.</p>

Using Cisco WebDialer

Cisco WebDialer allows you to make calls on your Cisco Unified IP Phone to directory contacts by clicking items in a web browser. Your system administrator must configure this feature for you.

If you want to...	Then...
Use WebDialer with your User Options directory	<ol style="list-style-type: none"> 1. Log into your User Options web pages. See the “Accessing Your User Options Web Pages” section on page 41. 2. Choose User Options > Directory and search for a coworker. 3. Click the number that you want to dial. 4. If this is your first time using WebDialer, set up preferences and click Submit. (See the last row in this table for details.) 5. If the Make Call page appears, click Dial. (See the last row in this table to learn how to suppress this page in the future, if desired.) The call is now placed on your phone. 6. To end a call, click Hangup or hang up from your phone.
Use WebDialer with another online corporate directory (not your User Options directory)	<ol style="list-style-type: none"> 1. Log into a WebDialer-enabled corporate directory and search for coworkers. 2. Click the number that you want to dial. 3. When prompted, enter your user ID and password. 4. If this is your first time using WebDialer, set up preferences and click Submit. (See the last row in this table for details.) 5. If the Make Call page appears, click Dial. (See the last row in this table to learn how to suppress this page in the future, if desired.) The call is now placed on your phone. 6. To end a call, click Hangup or hang up from your phone.

If you want to...	Then...
Log out of WebDialer	Click the logout icon in the Make Call or Hang Up page.
Set up, view, or change WebDialer preferences	<p data-bbox="338 230 661 263">Access the Preferences page.</p> <p data-bbox="338 269 1205 334">The Preferences page appears the first time that you use WebDialer (after you click the number that you want to dial.)</p> <p data-bbox="338 341 1171 406">To return to Preferences in the future, click the preferences icon from the Make Call or Hang Up page.</p> <p data-bbox="338 412 943 444">The Preferences page contains the following options:</p> <ul data-bbox="352 451 1205 917" style="list-style-type: none"> <li data-bbox="352 451 1138 516">• Preferred language—Determines the language used for WebDialer settings and prompts. <li data-bbox="352 522 1205 711">• Use permanent device—Identifies the Cisco Unified IP Phone and directory number (line) that you will use to place WebDialer calls. If you have one phone with a single line, the appropriate phone and line are automatically selected. Otherwise, choose a phone and/or line. Phones are specified by host name (To display the host name on your phone, choose  > Network Configuration > Host Name.) <li data-bbox="352 717 1205 815">• Use Extension Mobility—If selected, prompts WebDialer to use the Cisco Unified IP Phone that is associated with your Extension Mobility profile (if available). <li data-bbox="352 821 1205 917">• Do not display call confirmation—If selected, prompts WebDialer to suppress the Make Call page. This page appears by default after you click a phone number in a WebDialer-enabled online directory.

Understanding Additional Configuration Options

Your system administrator can configure your phone to use specific button and softkey templates along with special services and features, if appropriate. The table below provides an overview of some configuration options that you might want to discuss with your phone system administrator based on your calling needs or work environment.



Note

You can locate Phone Guides and other documents listed in this table on the web:
http://www.cisco.com/en/US/products/hw/phones/ps379/tsd_products_support_series_home.html

If you...	Then...	For more information...
Need to handle more calls on your phone line	Ask your system administrator to configure your line to support more calls.	Talk to your system administrator or phone support team.
Need more than one phone line	Ask your system administrator to configure one or more additional directory numbers for you.	Talk to your system administrator or phone support team.
Need more speed dial buttons	<p>First make sure that you are using all of your currently available speed dial buttons.</p> <p>If you need additional speed dial buttons, try using Abbreviated Dialing or subscribing to the Fast Dial service.</p> <p>Another option is to attach the Cisco Unified IP Phone 7914 Expansion Module to your phone.</p>	<p>See the:</p> <ul style="list-style-type: none"> • “Speed Dialing” section on page 24 • <i>Cisco Unified IP Phone Expansion Module 7914 Phone Guide</i>
Work with (or work as) an administrative assistant	<p>Consider using:</p> <ul style="list-style-type: none"> • The Cisco Unified Communications Manager Assistant service • A shared line 	<p>See the:</p> <ul style="list-style-type: none"> • “Using a Shared Line” section on page 26 • <i>Cisco Unified Communications Manager Assistant User Guide</i>

If you...	Then...	For more information...
Want to use one extension for several phones	Request a shared line. This allows you to use one extension number for your desk phone and lab phone, for example.	See the “Using a Shared Line” section on page 26.
Share phones or office space with co-workers	Consider using: <ul style="list-style-type: none"> • Call Park to store and retrieve calls without using the transfer feature. • Call Pickup to answer calls ringing on another phone. • A shared line to view or join coworkers’ calls. • Cisco Extension Mobility to apply your phone number and user profile to a shared Cisco Unified IP Phone 	Ask your system administrator about these features and see the: <ul style="list-style-type: none"> • “Advanced Call Handling” section on page 24 • “Using a Shared Line” section on page 26 • “Using Cisco Extension Mobility” section on page 31
Answer calls frequently or handle calls on someone’s behalf	Ask your system administrator to set up the AutoAnswer feature for your phone.	See the Using AutoAnswer with a Headset or Speakerphone, page 33.
Need to make video calls	Consider using Cisco Unified Video Advantage, which enables you to make video calls using your Cisco Unified IP Phone, your personal computer, and an external video camera.	Contact your system administrator for assistance and see the <i>Cisco Unified Video Advantage User Guide</i> and <i>Cisco Unified Video Advantage Quick Start Guide</i> .
Determine the state of a phone line associated with a speed-dial button on your phone	Ask your administrator to set up the Busy Lamp Field (BLF) feature for your phone.	See the “Using BLF to Determine a Line State” section on page 31.
Want to temporarily apply your phone number and settings to a shared Cisco Unified IP Phone	Ask your system administrator about the Cisco Extension Mobility service.	See the “Using Cisco Extension Mobility” section on page 31.

Troubleshooting Your Phone

This section provides troubleshooting information for your Cisco Unified IP Phone





General Troubleshooting

This section provides information to help you troubleshoot general problems with your phone. For more information, see your system administrator.

Symptom	Explanation
You cannot hear a dial tone or complete a call	One or more of the following factors might apply: <ul style="list-style-type: none"> You must log into the Extension Mobility service. You must enter a client matter code or forced authorization code after dialing a number. Your phone has time-of-day restrictions that prevent you from using some features during certain hours of the day.
The Settings button is unresponsive	Your system administrator might have disabled  on your phone.
The softkey that you want to use does not appear	One or more of the following factors might apply: <ul style="list-style-type: none"> You must press more to reveal additional softkeys. You must change the line state (for example, go off-hook or have a connected call). Your phone is not configured to support the feature associated with that softkey.
Join fails	Join requires multiple selected calls. Be sure that you have selected at least one call in addition to the active call, which is selected automatically. Join also requires the selected calls to be on the same line. If necessary, transfer calls to one line before joining them.
Barge fails and results in a fast busy tone	You cannot barge an encrypted call if the phone you are using is not configured for encryption. When your barge attempt fails for this reason, your phone plays a fast busy tone.
You are disconnected from a call that you joined using Barge	You will be disconnected from a call that you have joined using Barge if the call is put on hold, transferred, or turned into a conference call.
Call Back fails	The other party might have call forwarding enabled.

Viewing Phone Administration Data

Your system administrator might ask you to access administration data on your phone for troubleshooting purposes.

If you are asked to...	Then...
Access network configuration data	Choose  > Network Configuration and select the network configuration item that you want to view.
Access status data	Choose  > Status and select the status item that you want to view.
Access phone model information	Choose  > Model Information .
Access phone call and voice quality information	Choose  > Status > Call Statistics .

Using the Quality Reporting Tool

Your system administrator may temporarily configure your phone with the Quality Reporting Tool (QRT) to troubleshoot performance problems. You can press **QRT** to submit information to your system administrator. Depending on configuration, use the QRT to:

- Immediately report an audio problem on a current call.
- Select a general problem from a list of categories and choose reason codes.

Cisco One-Year Limited Hardware Warranty Terms

There are special terms applicable to your hardware warranty and various services that you can use during the warranty period. Your formal Warranty Statement, including the warranties and license agreements applicable to Cisco software, is available on Cisco.com at the following URL:

http://www.cisco.com/en/US/docs/general/warranty/English/1Y1DEN__.html

Replacement, Repair, or Refund Policy for Hardware

Cisco or its service center will use commercially reasonable efforts to ship a replacement part within ten (10) working days after receipt of a Return Materials Authorization (RMA) request. Actual delivery times can vary, depending on the customer location.

Cisco reserves the right to refund the purchase price as its exclusive warranty remedy.

To Receive a Return Materials Authorization (RMA) Number

Contact the company from whom you purchased the product. If you purchased the product directly from Cisco, contact your Cisco Sales and Service Representative.

Complete the information below, and keep it for reference.

Company product purchased from	
Company telephone number	
Product model number	
Product serial number	
Maintenance contract number	

Index

A

Abbreviated Dialing [44](#)
answering calls [15](#)
ASCII label field support [44](#)
audio, quality of [6](#)
authenticated calls [29](#)
AutoAnswer [33](#)

B

barge
 and privacy [28](#)
 and shared lines [26](#)
 using [27](#)
BLF [31](#)
Busy Lamp Field [31](#)

C

call activity area, viewing [10](#)
Call Back [14](#)
call forwarding
 configuring from web page [47](#)
 configuring on phone [19](#)
call logs
 erasing [36](#)
 viewing and dialing from [36](#)

call overview mode [17](#)
call park [28](#)
call waiting [15](#)
caller ID [10](#)
call-handling, advanced [24](#)
call-handling, basic [13](#)
calls
 answering [15](#)
 barging [26](#)
 compared to lines [12](#)
 conference features for [20](#)
 ending [16](#)
 forwarding [19, 47](#)
 handling multiple [17](#)
 holding and resuming [16](#)
 icons for [12](#)
 multiple parties on [20](#)
 multiple, switching between [17](#)
 muting [16](#)
 parking [28](#)
 placing [13, 14](#)
 prevent barging of [28](#)
 prioritizing [30](#)
 reporting problems with [54](#)
 secure [29](#)
 selecting [12](#)
 storing and retrieving [28](#)

- transferring [18](#)
- using Join with [21](#)
- viewing [10, 17](#)
- cBarge
 - See also barge
 - using [27](#)
- Cisco Extension Mobility [31](#)
- Cisco Unified Communications Manager
 - Address Book Synchronizer [44](#)
- Cisco Unified IP Phone
 - adjusting height of [4](#)
 - connecting [4](#)
 - description of [7](#)
 - documentation for [2](#)
 - feature configuration for [11, 12, 51](#)
 - illustration of [7](#)
 - online help for [11](#)
 - registering [5](#)
 - securing handset rest [5](#)
 - web-based services for [41](#)
- Cisco Unified IP Phone Expansion Module 7914 [35, 51](#)
- Cisco Unified Video Advantage [52](#)
- Cisco WebDialer [49](#)
- conference
 - joining [22](#)
 - secure [22](#)
- conference calls
 - Meet-Me [20, 23](#)
 - standard [20, 21](#)
- corporate directory
 - using from web page [49](#)
 - using on phone [37](#)

D

- device configuration page [41](#)
- dialing, options for [13, 14](#)
- directories button, description of [9](#)
- directory
 - corporate [37](#)
 - personal [37, 38](#)
 - using from web page [49](#)
 - using on phone [36, 37](#)
- documentation, accessing [2](#)

E

- EM [31](#)
- encrypted calls [29](#)
- ending a call, options for [16](#)
- Extension Mobility [31](#)
 - log in [31](#)
 - log out [31](#)
- extension numbers, viewing [10](#)

F

- Fast Dials
 - configuring from web page [43](#)
 - using on phone [38](#)
- feature buttons
 - directories [9](#)
 - help [9, 17](#)
 - messages [9](#)
 - services [9](#)
 - settings [9](#)
- features, availability of [11, 12](#)

- footstand
 - adjusting [4](#)
 - button, identifying [8](#)
- forwarding calls, options for [19](#)

H

- handset
 - light strip [8](#)
 - securing in cradle [5](#)
 - using [32](#)
 - volume [34](#)
- hanging up, options for [16](#)
- headset
 - answering calls with [15](#)
 - button, identifying [9](#)
 - hanging up with [16](#)
 - mode, using [32](#)
 - placing calls with [13](#)
 - volume [34](#)
- headset performance, general [5](#)
- help button [17](#)
- help button, description of [9, 17](#)
- help, using [11](#)
- hold
 - and switching calls [17](#)
 - and transferring [18](#)
 - using [16](#)

I

- icons
 - for call states [12](#)

- for lines [12](#)
- installing, Cisco Unified IP Phone [4](#)
- IP [35](#)

J

- Join, using [21](#)

K

- keypad
 - description of [9](#)

L

- language (locale) settings [46](#)
- line buttons, identifying [8](#)
- lines
 - and call forwarding [19, 47](#)
 - and call states [12](#)
 - and using BLF [31](#)
 - description of [12](#)
 - icons for [12](#)
 - number of calls supported on [12](#)
 - ring patterns for [47](#)
 - switching between [17](#)
 - text label for [47](#)
 - viewing [10](#)
 - voice message indicator setting for [47](#)

M

- Malicious Call Identification (MCID) [29](#)

Meet-Me conferences [20, 23](#)
messages
 indicator for [40](#)
 listening to [40](#)
messages button, description of [9](#)
missed calls, records of [36](#)
MLPP, using [30](#)
multiple calls, handling [17](#)
mute button, description of [9](#)
mute, using [16](#)

N

navigation button, description of [9](#)
network configuration data, locating [53](#)

O

online help, using [11](#)

P

PAB
 using from web page [42](#)
 using on phone [38](#)
password, changing [46](#)
Personal Address Book, see PAB
Personal Directory
 using from web page [42](#)
 using on phone [38](#)
phone lines
 buttons for [8](#)
 description of [12](#)

 viewing [10](#)
phone screen
 adjusting contrast of [35](#)
 changing language of [35](#)
 cleaning [10](#)
 features of [10](#)
phone services, configuring [42](#)
PIN, changing [46](#)
placed calls, records of [36](#)
placing calls, options for [13, 14](#)
prioritizing calls [30](#)
privacy
 and shared lines [26](#)
 using [28](#)
programmable buttons
 description of [8](#)
 labels for [10](#)

Q

QRT, using [54](#)

R

received calls, records of [36](#)
redial [13](#)
remote-in-use icon for shared lines [26](#)
resume, using [16](#)
ring patterns, changing [47](#)
ringer
 indicator for [8](#)
 volume [34](#)

S

- safety, warnings [2](#)
- secure calls [29](#)
- secure conference
 - verifying [22](#)
- selecting calls [12](#)
- services button, description of [9](#)
- services, subscribing to [45](#)
- settings
 - using [34](#)
- settings button, description of [9](#)
- shared lines
 - and remote-in-use icon [26](#)
 - description of [26](#)
 - with barge [27](#)
 - with privacy [28](#)
- softkey buttons
 - description of [9, 10](#)
 - labels for [10](#)
- speakerphone
 - answering calls with [15](#)
 - button, identifying [9](#)
 - hanging up with [16](#)
 - mode, using [32](#)
 - placing calls with [13](#)
 - volume [34](#)
- speed dial
 - buttons, configuring [24](#)
 - buttons, identifying [8](#)
 - configuring [44](#)
 - labels [10, 44](#)
 - using [14](#)
- status data, locating [53](#)

- status line, viewing [10](#)
- subscriptions, for phone services [45](#)
- suspicious calls, tracing [29](#)
- switching calls [17](#)

T

- TAPS, using [5](#)
- text, entering on phone [11](#)
- Tool for Auto-Registered Phones Support [5](#)
- transferring, options for [18](#)
- troubleshooting, data for [53](#)

U

- User Options web pages
 - accessing [41](#)
 - configuring features and services with [42](#)
 - subscribing to phone services with [45](#)

V

- voice message indicator
 - changing setting for [47](#)
- voice message indicator, identifying [40](#)
- voice message service, using [40](#)
- volume
 - adjusting [34](#)
- volume button, description of [9](#)

W

- warnings, safety [2](#)

warranty information **55**

WebDialer **49**



Americas Headquarters
Cisco Systems, Inc.
San Jose, CA

Asia Pacific Headquarters
Cisco Systems (USA) Pte. Ltd.
Singapore

Europe Headquarters
Cisco Systems International BV
Amsterdam, The Netherlands

Cisco has more than 200 offices worldwide. Addresses, phone numbers, and fax numbers are listed on the
Cisco Website at www.cisco.com/go/offices.

CCDE, CCENT, Cisco Eos, Cisco Lumin, Cisco Nexus, Cisco StadiumVision, the Cisco logo, DCE, and Welcome to the Human Network are trademarks; Changing the Way We Work, Live, Play, and Learn is a service mark; and Access Registrar, Aironet, AsyncOS, Bringing the Meeting To You, Catalyst, CCDA, CGBP, CCIE, CCIP, GCNA, CCNP, CCSP, CCVP, Cisco, the Cisco Certified Internetwork Expert logo, Cisco IOS, Cisco Press, Cisco Systems, Cisco Systems Capital, the Cisco Systems logo, Cisco Unity, Collaboration Without Limitation, EtherFast, EtherSwitch, Event Center, Fast Step, Follow Me Browsing, FormShare, GigaDrive, HomeLink, Internet Quotient, IOS, iPhone, iQ Expertise, the iQ logo, iQ Net Readiness Scorecard, iQuick Study, IronPort, the IronPort logo, LightStream, Linksys, MediaTone, MeetingPlace, MGX, Networkers, Networking Academy, Network Registrar, PCNow, PIX, PowerPanels, ProConnect, ScriptShare, SenderBase, SMARTnet, Spectrum Expert, StackWise, The Fastest Way to Increase Your Internet Quotient, TransPath, WebEx, and the WebEx logo are registered trademarks of Cisco Systems, Inc. and/or its affiliates in the United States and certain other countries.

All other trademarks mentioned in this document or Website are the property of their respective owners. The use of the word partner does not imply a partnership relationship between Cisco and any other company. (0805R)



The Java logo is a trademark or registered trademark of Sun Microsystems, Inc. in the U.S. or other countries.

© 2008 Cisco Systems, Inc. All rights reserved.